











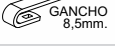
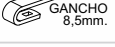
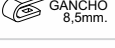

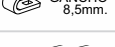

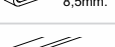
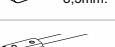













**PALHETA P/ LIMPADOR DIANTEIRO CONVENCIONAL**

Código	Polegadas	Milímetros	Embalagem	Conexão	Aplicação	Conversão
VTOPVC2000	20"	500	PEÇA	 GANCHO 8,5mm.	INTERNATIONAL 9800 APÓS 10	1653422C91D
VTOPVC2097	20"	500	PEÇA	 BAIONETA	AGRALE / MERCEDES 3 LIMPADORES / 608 PUMA T4 / T6 / VW CAM. 81 A 92	DNA20341 DYNA0097 EDN000097
VTOPVC2200	22"	550	PEÇA	 GANCHO 8,5mm.	DAF F95 / XF / XF95 / XF105	1954654
VTOPVC2400	24"	600	PEÇA	 GANCHO 8,5mm.	SCANIA P 96 A 98 / T / R 91 A 98	DYNA0100
VTOPVC2401	24"	600	PEÇA	 GANCHO 8,5mm.	VW CONSTELLATION	-----
VTOPVC2402	24"	600	PEÇA	 GANCHO 8,5mm.	DAF CF13 / CF65 / CF75 / CF85 / F65 / F75	1688251
VTOPVC2472	24"	600	PEÇA	 GANCHO 8,5mm.	INTERNATIONAL / MERCEDES 715 / 915 / 1620 ACCELO / HPN / L / LS / VW DELIVERY / WORKER	DNA24901 DYNA0172 EDN000172 VTOPVF2472
VTOPVC2474	24"	600	PEÇA	 PARAFUSO	AGRALE 6000 / 7000 / MERCEDES 709 / 710 / 914 SCANIA T / R / VW CAM. APÓS 99	EDN000174 VTOPVF2474
VTOPVC2662	26"	650	PEÇA	 GANCHO 8,5mm.	IVECO TECTOR / STRALIS / EURO 98 A 12 / ATEGO ATRON / AXOR / VOLVO FH / FM / NH	DNA26901 DYNA162 EDN000164 VTOPVC2662
VTOPVC2665	26"	650	PEÇA	 GANCHO 8,5mm.	MERCEDES ATEGO / AXOR / IVECO STRALIS	DNA226900 DYNA0164 EDN000164
VTOPVC2671	26"	650	PEÇA	 PARAFUSO	FORD CARGO	DNA26908 DYNA0171 EDN000171
VTOPVC2768	27"	675	PEÇA	 GANCHO	MAN TGL / TGM / TGS / TGX / TGX V8 / MBB ACTROS SCANIA SÉRIE 4 / SCANIA SÉRIE 5	DNA27901 DYNA0168 EDN000168 VTOPVF2768
VTOPVC2800	28"	700	PEÇA	 GANCHO	MERCEDES ACTROS APÓS 2016	-----
VTOPVC2801	28"	700	PEÇA	 GANCHO LARGO 11,8mm.	VOLVO FH12 / 13 / 16 APÓS 2013 VOLVO FH NOVO APÓS 2020 SCANIA SÉRIE 5 APÓS 2010	 C/ ESGUICHO 824856
VTOPVC2802	28"	700	PEÇA	 GANCHO LARGO 11,8mm.	VOLVO FH 16 APÓS 2015 VW METEOR APÓS 2020	82485683
VTOPVC2876	28"	700	PEÇA	 PARAFUSO	MERCEDES O370 / O371 / O400 / BUSSCAR NIELSON / CAIO / CIFERAL / COMIL / MARCOPOLO MAFERSA / MASCARELO	DYNA0176

**PALHETA P/ LIMPADOR DIANTEIRO TOP LINE**

Código	Polegadas	Milímetros	Embalagem	Conexão	Aplicação	Conversão
VTOPVT13	13"	330	PEÇA	 GANCHO 8,5mm.	VW / FIAT / GM / HONDA / SCANIA	-----
VTOPVT14	14"	350	PEÇA	 GANCHO 8,5mm.	HONDA / HYUNDAI / NISSAN / SUZUKI	DYNAS14
VTOPVT15	15"	380	PEÇA	 GANCHO 8,5mm.	FIAT IDEA / FORD F-1000 APÓS 92 GM OPALA / VERANEIO / VW FOX	DYNAS15 VTOPVF15
VTOPVT16	16"	400	PEÇA	 GANCHO 8,5mm.	TOPIC / TOWNER / PAMPA / FIT 03 A 08 PEUGEOT 206 / 207 / SCENIC / GOL GV	DYNAS16 VTOPVF16
VTOPVT17	17"	430	PEÇA	 GANCHO 8,5mm.	FORD KA / ALFA ROMEO SPIDER	VTOPVF17
VTOPVT18	18"	450	PEÇA	 GANCHO 8,5mm.	CITROËN / FIAT / FORD / GM / HONDA / KIA RENAULT / TOYOTA / VW	DYNAS18 VTOPVF18
VTOPVT19	19"	475	PEÇA	 GANCHO 8,5mm.	AUDI / FIAT / FORD KA / FUSION / GM / HONDA MITSUBISHI / GOL GIII / IV / BORA / GOLF / POLO	DYNAS19 DYNA0175 VTOPVF19
VTOPVT20	20"	500	PEÇA	 GANCHO 8,5mm.	CITROËN / FIAT / FORD / GM / HONDA / PEUGEOT RENAULT / TOYOTA / VW	DYNAS20 VTOPVF20
VTOPVT21	21"	530	PEÇA	 GANCHO 8,5mm.	AUDI / CITROËN / FORD / OMEGA / HONDA PEUGEOT / RENAULT / GOL GII / IV / BORA / GOLF	DYNAS21 VTOPVF21
VTOPVT22	22"	550	PEÇA	 GANCHO 8,5mm.	AUDI A6 / A8 / BERLINGO / FIAT DUCATO APÓS 98 GM / BOXER / PARTNER / VOLVO S60	DYNAS22 VTOPVF22
VTOPVT23	23"	580	PEÇA	 GANCHO 8,5mm.	CITROËN / FIAT / FORD / HONDA HYUNDAI / RENAULT / TOYOTA	VTOPVF23
VTOPVT24	24"	600	PEÇA	 GANCHO 8,5mm.	FORD / GM / KIA / FIAT / MAZDA TOYOTA / TOYOTA / HYUNDAI	DYNAS24 VTOPVF24
VTOPVT24R	24"	600	PEÇA	 GANCHO 8,5mm.	SPACE 91 / MASTER 97 A 99 VOLVO VM 03 A 17	GRA24249E
VTOPVT26	26"	650	PEÇA	 GANCHO 8,5mm.	CITROËN PICASSO / PEUGEOT 206 / 207 / 307 RENAULT TWINGO	DYNAS26 VTOPVF26
VTOPVT28	28"	700	PEÇA	 GANCHO 8,5mm.	PEUGEOT 307 / COROLLA / GOL	DNA28406 DYNA0177 EDN000177 VTOPVF28

## PALHETA P/ LIMPADOR DIANTEIRO FLEX

Código	Polegadas	Milímetros	Embalagem	Conexão	Aplicação	Conversão
<b>VTOPVF15</b>	15"	380	PEÇA	L GANCHO 8,5mm.	FIAT IDEA / FORD F-1000 APÓS 92 GM OPALA / VERANEIO / VW FOX	DYNAS15 VTOPVF15
<b>VTOPVF16</b>	16"	400	PEÇA	L GANCHO 8,5mm.	TOPIC / TOWNER / PAMPA / HONDA FIT PEUGEOT / SCENIC / GOL GV	DYNAS16 VTOPVF16
<b>VTOPVF17</b>	17"	430	PEÇA	L GANCHO 8,5mm.	FORD KA / ALFA ROMEO SPIDER	VTOPVF17
<b>VTOPVF18</b>	18"	450	PEÇA	L GANCHO 8,5mm.	CITROËN / FIAT / FORD / GM / HONDA KIA / RENAULT / TOYOTA / VW	DYNAS18 VTOPVF18
<b>VTOPVF19</b>	19"	475	PEÇA	L GANCHO 8,5mm.	AUDI / FIAT / KA / FUSION / GM / HONDA MITSUBISHI / GOL GIII / IV / BORA / GOLF / POLO	DYNAS19 DYNA0175 VTOPVF19
<b>VTOPVF20</b>	20"	500	PEÇA	L GANCHO 8,5mm.	CITROËN / FIAT / FORD / GM / HONDA PEUGEOT / RENAULT / TOYOTA / VW	DYNAS20 VTOPVF20
<b>VTOPVF21</b>	21"	530	PEÇA	L GANCHO 8,5mm.	AUDI / CITROËN / FORD / OMEGA / HONDA PEUGEOT / RENAULT / GOL GII / IV / BORA / GOLF	DYNAS21 VTOPVF21
<b>VTOPVF22</b>	22"	550	PEÇA	L GANCHO 8,5mm.	AUDI A6 / A8 / BERLINGO / DUCATO APÓS 98 GM / BOXER / PARTNER / VOLVO S60	DYNAS22 VTOPVF22
<b>VTOPVF23</b>	23"	580	PEÇA	L GANCHO 8,5mm.	CITROËN / FIAT / HONDA / RENAULT / FOX	VTOPVF23
<b>VTOPVF24</b>	24"	600	PEÇA	L GANCHO 8,5mm.	FORD / GM / KIA / MERCEDES CLASSE C / E / CLK / A	DYNAS24 VTOPVF24
<b>VTOPVF26</b>	26"	650	PEÇA	L GANCHO 8,5mm.	CITROËN PICASSO / PEUGEOT 206 / 207 / 307 / RENAULT TWINGO	DYNAS26 VTOPVF26
<b>VTOPVF28</b>	28"	700	PEÇA	L GANCHO 8,5mm.	PEUGEOT 307 / 307SW / TOYOTA / VW	DNA28408 DYNA0177 EDN000177 VTOPVT28
<b>VTOPVF2424C</b>	24" / 24"	600 / 600	PAR	L	ASIA / FIAT / GM / MERCEDES C180 08 A 2011 RENAULT / TOYOTA / VW	.....
<b>VTOPVF2472</b>	24"	600	PEÇA	P GANCHO 8,5mm.	INTERNATIONAL / MERCEDES 715 / 915 / 1620 ACCELO / HPN / L / LS / VW DELIVERY / WORKER	DNA24901 DYNA0172 EDN000172 VTOPVC2472
<b>VTOPVF2474</b>	24"	600	PEÇA	P PARAFUSO	AGRALE 6000 / 7000 / MERCEDES 709 / 710 / 914 SCANIA T / R / VW CAM. APÓS 99	DNA24908 DYNA0174 EDN000174 VTOPVC2474
<b>VTOPVF2662</b>	26"	650	PEÇA	P GANCHO 8,5mm.	IVECO TECTOR / STRALIS / EURO 98 A 12 MERCEDES ATEGO / ATRON / AXOR / VOLVO FH / FM / NH	DNA26901 DYNA0168 EDN000168 VTOPVC2662
<b>VTOPVF2768</b>	27"	675	PEÇA	P GANCHO 8,5mm.	MAN TGL / TGM / TGS / TGX / TGX V8 / MBB ACTROS SCANIA SÉRIE 4 / SCANIA SÉRIE 5	DNA27901 DYNA0168 EDN000168 VTOPVC2768

**VTOBF12** 50.012.536 - EDNUV03021  
TSA821002A / VDO24608203021



1 ENTRADA BICO FINO  
1 SAÍDA BICO FINO

**BOMBA ÁGUA PARA-BRISAS - 12V.  
BOMBA PARTIDA A FRIO - 12V.**

**VTOBF12C** 377955651 / 93276186  
TSA806008G



1 ENTRADA BICO FINO  
1 SAÍDA BICO FINO

**BOMBA ÁGUA PARA-BRISAS - 12V.  
BOMBA PARTIDA A FRIO - 12V.**

**VTOBF12V** 1J5955651MY



1 ENTRADA BICO FINO  
1 SAÍDA BICO FINO

**BOMBA ÁGUA PARA-BRISAS - 12V.  
BOMBA PARTIDA A FRIO - 12V.**

**VTOBF24** 838003A - EDNUV03001  
TSA838003A / VDO24608203001



1 ENTRADA BICO FINO  
1 SAÍDA BICO FINO

**BOMBA ÁGUA PARA-BRISAS - 24V.**

**VTOBG12** 481016A / 20607 / 56961  
TSA481016A



1 ENTRADA BICO GROSSO  
1 SAÍDA BICO FINO

**BOMBA ÁGUA PARA-BRISAS - 12V.  
BOMBA PARTIDA A FRIO - 12V.**

**VTOBF2S** 802004A / 80261  
TSA802004A



1 ENTRADA BICO FINO  
2 SAÍDAS BICO FINO

**BOMBA ÁGUA PARA-BRISAS - 12V.  
UNIVERSAL**

**VTOBF2SC** 377955651A / 569017G  
TSA807005A



1 ENTRADA BICO FINO  
2 SAÍDAS BICO FINO

**BOMBA ÁGUA PARA-BRISAS - 12V.  
ASTRA / GOL / PARATI**

**VTOBG24** TSA472015A



1 ENTRADA BICO GROSSO  
1 SAÍDA BICO FINO

**BOMBA ÁGUA PARA-BRISAS - 24V.**

**VTOBG2S** 85661  
TSA856018A



1 ENTRADA BICO GROSSO  
2 SAÍDAS BICO FINO

**BOMBA ÁGUA PARA-BRISAS - 12V.  
FIESTA / KA / PEUGEOT 206 / 207 / 306 / 307**

**VTO00042** GAGB1066



2 CORNETAS

**BUZINA ELETROPNEUMÁTICA - 12V.**

**VTO00064** GAGB1067



3 CORNETAS

**BUZINA ELETROPNEUMÁTICA - 12V.**

**VTO00047** GAGB1068



C/ SOLENOÍDE

**BUZINA ELETROPNEUMÁTICA - 12V.**

**VTO00043** GAGB1005

**P**



30cm.  
C/ SOLENÓIDE

BUZINA ELETROPNEUMÁTICA - 12V.

**VTO00044** GAGB1006

**P**



30cm.  
C/ SOLENÓIDE

BUZINA ELETROPNEUMÁTICA - 24V.

**VTO00054**

**P**



45cm.  
C/ SOLENÓIDE

BUZINA ELETROPNEUMÁTICA - BIVOLT

**VTO00301C** BER2011 / GAGB1009

**P**



49cm.  
C/ MOTOR

BUZINA ELETROPNEUMÁTICA - 12V.

**VTO00115** GAGB1061 / HEL3AL012588291

**U**



Æ12mm.  
INDIVIDUAL

BUZINA BIBI - 12V. - PAQUERINHA

**VTO00135** GAGB1060 / HEL3AM012588341

**U**



Æ12mm.  
DUPLA

BUZINA BIBI - 12V. - PAQUERINHA

**VTO00133** GAGB1063

**P**



Æ12mm.  
DUPLA

BUZINA BIBI - 24V. - PAQUERINHA

**VTO00112** GAGB1064

**U**



Æ123mm.  
INDIVIDUAL

BUZINA BIBI - 12V. - GRANDE

**VTO00113** GAGB1065

**P**



Æ123mm.  
INDIVIDUAL

BUZINA BIBI - 24V. - GRANDE

**VTO00211** GAGB1050

**U**



INDIVIDUAL  
1 TERMINAL

BUZINA CARACOL - 12V.

**VTO00213** GAGB1052 / HEL3FG011225171

**U**



INDIVIDUAL  
2 TERMINAIS

BUZINA CARACOL - 12V.

**VTO00215** GAGB1054 / HEL3FH011225161

**L**



DUPLA  
2 TERMINAIS

BUZINA CARACOL - 12V.

**VTO00209** GAGB1055

**L**



INDIVIDUAL  
CONECTOR ORIGINAL

BUZINA CARACOL - 12V. - 2T.  
FIAT

**VTO00210** GAGB1057

**L**



INDIVIDUAL  
CONECTOR ORIGINAL

BUZINA CARACOL - 12V. - 2T.  
VW APÓS 98

**VTO00214** GAGB1051

**L**



INDIVIDUAL  
CONECTOR ORIGINAL

BUZINA CARACOL - 12V. - 2T.  
GM

**VTOCV1206**

**U**



VENTILADOR - 6" - 12V.

**VTOCV1208**

**U**



VENTILADOR - 8" - 12V.

**VTOCV2406**

**U**



VENTILADOR - 6" - 24V.

**VTO08540** 1870553 / 1779757

**P**



MEDIDA: 22x74x39

POLIA DESVIADORA DO ALTERNADOR  
SCANIA G / P / R APÓS 2008 C/ DC13

**VTKV500** 9.121.456.117

**P**



• ALTERNADOR T1 / HD-1 - 75 A 150A.  
01 ROLAMENTO NB107  
01 ROLAMENTO 6506  
01 RETENTOR

ROLAMENTOS ALTERNADOR (KIT)

**VTO00608** 2.600.905.052  
NSK0608

**U**



• MOTOR VIDRO ELÉTRICO  
• MOTOR LIMPADOR  
• VENTONINHA  
GM / VW / FORD  
• EXIGI PROTEÇÃO

MEDIDAS EM mm.:  
8(Æ) x 22(Æ) x 7(L)

ROLAMENTO DE ESFERAS - 2RS

**VTO00629** NSK0629

**U**



• FERRAMENTAS ELÉTRICA  
BOSCH / MAKITA

MEDIDAS EM mm.:  
9(Æ) x 26(Æ) x 8(L)

ROLAMENTO DE ESFERAS - 2RS

**VTO06000** NSK6000

**U**



• ALTERNADOR DELCO CS144  
• MOTOS HONDA  
CB400CC EMBRAGAGEM

MEDIDAS EM mm.:  
10(Æ) x 26(Æ) x 8(L)

ROLAMENTO DE ESFERAS - 2RS

**VTO06001** NSK6001



• ALTERNADOR BESTA / TOPIC  
• DIREÇÃO PINHÃO CORCEL II / DEL REY / PAMPA GOL / PASSEI / SANTANA  
• MOTOS HONDA CG TITAN 125cc EMBREAGEM

MEDIDAS EM mm.: 12(Æ) x 28(Æ) x 8(L)

ROLAMENTO DE ESFERAS - 2RS

**VTO06002** NSK6002



• PARTIDA JE - BB SCANIA  
• PARTIDA DELCO  
• MOTOS HONDA

MEDIDAS EM mm.: 15(Æ) x 32(Æ) x 9(L)

ROLAMENTO DE ESFERAS - 2RS

**VTO06003** F00M990405 NSK6003



• ALT. PALIO - BB / MM  
• PARTIDA 28MT - DR  
• MOTOS YAMAHA CRYPTON EXO COMANDO VÁLVULA YBR 125cc EXO COMANDO XT 600cc  
• MOTOS HONDA CG TITAN 150cc EMBREAGEM

MEDIDAS EM mm.: 17(Æ) x 35(Æ) x 10(L)

ROLAMENTO DE ESFERAS - 2RS

**VTO06004** 11130 / 13130 / 14140 / 144280 NSK6004



• BOMBA HIDRÁULICA VW 11-130 / 13-130 / 14-140  
• CÂMBIO PINHÃO OPLA / VECTRA SCANIA  
• PARTIDA MITSUBISHI

MEDIDAS EM mm.: 20(Æ) x 42(Æ) x 12(L)

ROLAMENTO DE ESFERAS - 2RS

**VTO06005** 10456463 NSK6005



• PARTIDA DELCO 28MT / FIAT ALLIS  
• BOMBA D'ÁGUA VOLVO 958

MEDIDAS EM mm.: 25(Æ) x 47(Æ) x 12(L)

ROLAMENTO DE ESFERAS - 2RS

**VTO06200** NSK6200



• ALTERNADOR BB / WA CORCEL / BELINA F-100 / F-800 LANDAU / TOYOTA  
• PARTIDA DELCO 28MT - L. COLETOR

MEDIDAS EM mm.: 10(Æ) x 30(Æ) x 9(L)

ROLAMENTO DE ESFERAS - 2RS

**VTO06201** NSK6201



• ALTERNADOR BB / WA MERCEDES CAM - L. POLIA FIAT / GM / VW LINHA LEVE  
• ALAVANCA EMBREAGEM SCANIA LLS 75 / 110 / 111 ARTICULADO 8110  
• MOTOS HONDA BIZ 100 / 125cc ARVORE SECUNDÁRIA

MEDIDAS EM mm.: 12(Æ) x 32(Æ) x 10(L)

ROLAMENTO DE ESFERAS - 2RS

**VTO06202** NSK6202



• ALT. / DINAMO BB / WA FUSCA / BRASLIA / KOMBI  
• PARTIDA BOSCH ZE - MERCEDES  
• MOTOS YAMAHA YBR 125cc RODA TRASEIRA XTZ 125cc RODA DIANTEIRA

MEDIDAS EM mm.: 15(Æ) x 35(Æ) x 11(L)

ROLAMENTO DE ESFERAS - 2RS

**VTO06203** NSK6203



• DINAMO BB / WA  
• ALT. VW / FORD  
• MOTOS YAMAHA CRYPTON EXO PRINCIPAL YBR 125cc EXO PRINCIPAL XTZ 125cc EXO PRINCIPAL  
• MOTOS HONDA BIZ 100 / 125cc ARVORE SECUNDÁRIA BIZ 100 / 125cc ARVORE PRINCIPAL

MEDIDAS EM mm.: 17(Æ) x 40(Æ) x 12(L)

ROLAMENTO DE ESFERAS - 2RS

**VTO06204** NSK6204



• ALT. WAPSA FORD GARDIO F-1000 / F-4000  
• SUPORTE CARDAN AGRALE / TRATORES 4100  
• CONJ. EMBREAGEM MANOBI  
• MOTOS YAMAHA CRYPTON EXO SECUNDÁRIO YBR 125cc EXO SECUNDÁRIO XTZ 125cc TRANS. EXO SECUNDÁRIO  
• MOTOS HONDA CG TITAN 125cc ARVORE SEC. CG TITAN 150cc TRANSMISSÃO

MEDIDAS EM mm.: 20(Æ) x 47(Æ) x 14(L)

ROLAMENTO DE ESFERAS - 2RS

**VTO06205** NSK6205



• SUP. CARDAN AGRALE 4200 / 4300  
• BOMBA D'ÁGUA SCANIA / VOLVO  
• VIRABREQUIM MERCEDES OM 255 / 356  
• MOTOS YAMAHA CRYPTON VIRABREQUIM L.E.

MEDIDAS EM mm.: 25(Æ) x 52(Æ) x 15(L)

ROLAMENTO DE ESFERAS - 2RS

**VTO06206** NSK6206



• ALTERNADOR BOSCH  
• BOMBA D'ÁGUA MERCEDES CAM  
• EIXO INTERMEDIÁRIO AGRALE 4200 / 4300  
• TOMADA POTÊNCIA MERCEDES OM BUS  
• ÁRVORE SECUNDÁRIA MONZA / PASSET

MEDIDAS EM mm.: 30(Æ) x 62(Æ) x 16(L)

ROLAMENTO DE ESFERAS - 2RS

**VTO06301** NSK6301



• MOTOS HONDA CG ML / ALX RODA DIANTEIRA

MEDIDAS EM mm.: 12(Æ) x 37(Æ) x 12(L)

ROLAMENTO DE ESFERAS - 2RS

**VTO06302** 00625006302 NSK6302



• POLIA ESTICADORA MERCEDES  
• MOTOS HONDA CG ML / ALX - RODA TRASEIRA

MEDIDAS EM mm.: 15(Æ) x 42(Æ) x 13(L)

ROLAMENTO DE ESFERAS - 2RS

**VTO06303** NSK6303



• ALTERNADOR MERCEDES OM 386 / 447 / L / LO VW 11-130 / 11-140

MEDIDAS EM mm.: 17(Æ) x 47(Æ) x 14(L)

ROLAMENTO DE ESFERAS - 2RS

**VTO06304** NSK6304



• VENTILADOR MERCEDES  
• TOMADA POTÊNCIA MERCEDES OM 352 / VALMET  
• EIXO PILOTO CÂMBIO PASSET - TRASEIRO  
• ÁRVORE MERCEDES OM BUS  
• MOTOS HONDA BIZ 100cc VIRABREQUIM

MEDIDAS EM mm.: 20(Æ) x 52(Æ) x 15(L)

ROLAMENTO DE ESFERAS - 2RS

**VTO06306** NSK6306



• ALT. BOSCH T1 / HD1 75 A 105A  
• RODA TRASEIRA TOMNER  
• MOTORES ELÉTRICOS

MEDIDAS EM mm.: 30(Æ) x 72(Æ) x 19(L)

ROLAMENTO DE ESFERAS - 2RS

**VTO06403** 1.120.900.010



• ALTERNADOR BOSCH MERCEDES / SCANIA / VOLVO

MEDIDAS EM mm.: 17(Æ) x 42(Æ) x 17(L)

ROLAMENTO DE ESFERAS - 2RS

**VTO06903** SKF - 6903



• MOTOS HONDA CB250 / XE250 EMBREAGEM

MEDIDAS EM mm.: 17(Æ) x 30(Æ) x 7(L)

ROLAMENTO DE ESFERAS - 2RS

**VTO06904** SKF - 6904



• MOTOS SUZUKI RM125 / RM250 / DRZ400E RODA DIANTEIRA  
• ALTERNADOR L-200

MEDIDAS EM mm.: 20(Æ) x 37(Æ) x 9(L)

ROLAMENTO DE ESFERAS - 2RS

**VTO62201** NSK62201



• ALTERNADOR MERCEDES / SCANIA VOLVO / TOYOTA

MEDIDAS EM mm.: 12(Æ) x 32(Æ) x 14(L)

ROLAMENTO DE ESFERAS - 2RS

**VTO6230417** 1.120.905.103



• ALTERNADOR BOSCH MERCEDES / MODERNO VOLVO / SCANIA

MEDIDAS EM mm.: 17(Æ) x 52(Æ) x 21(L)

ROLAMENTO DE ESFERAS - 2RS

**VTO63001** NSK63001



• ALTERNADOR TEMPERA / TIPO / F-250

MEDIDAS EM mm.: 12(Æ) x 28(Æ) x 12(L)

ROLAMENTO DE ESFERAS - 2RS

**VTO630417** SKF630417



• ALTERNADOR VALMET / MERCEDES OM352 / GOL GI - BOLA / PASSAT

MEDIDAS EM mm.: 17(AB) x 52(ABx) x 15(L)

ROLAMENTO DE ESFERAS - 2RS

**VTOB17107D** S903P64470 / TMB303LU



• ALTERNADOR MITSUBISHI

MEDIDAS EM mm.: 17(AB) x 47(ABx) x 18(L)

ROLAMENTO DE ESFERAS - 2RS

**VTOB17116** F3LY10A303A / S930P80570 / GEE- 331 / NSKB17116



• FORD / MITSUBISHI / MOTORCRAFT

MEDIDAS EM mm.: 17(AB) x 52(ABx) x 18(L)

ROLAMENTO DE ESFERAS - 2RS

**VTOB1027D**

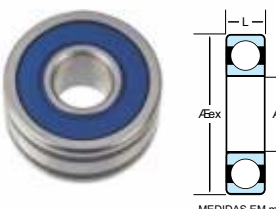

• ALTERNADOR MITSUBISHI

MEDIDAS EM mm.: 10(AB) x 27(ABx) x 14(L)

ROLAMENTO DE ESFERAS - 2RS

**VTOB1799D** 1-120-905-012 / 592936 / DR19025387L / DR10514528 / NSKB1799



• ALTERNADOR INVOLES / GOL - VALEO

MEDIDAS EM mm.: 17(AB) x 52(ABx) x 17(L)

ROLAMENTO DE ESFERAS - 2RS

**VTOB17126DW** NSKB17126



• ALTERNADOR 55A / MERCEDES NOVO

MEDIDAS EM mm.: 17(AB) x 62(ABx) x 7,5(L)

ROLAMENTO DE ESFERAS - 2RS

**VTOB17127DG** 1.120.905.097



• ALTERNADOR SCANIA 114 / 124 / MERCEDES VOLVO

MEDIDAS EM mm.: 17(AB) x 62(ABx) x 20(L)

ROLAMENTO DE ESFERAS - 2RS

**VTONB101** 5536314 / 9.902.455.030



• ALTERNADOR WAPSA / ARNO / OPALA / MONZA / D-20 / CORCEL II / MAVERICK / F-350 / F-600 / POLARA 1800

MEDIDAS EM mm.: 12(AB) x 28(ABx) x 8(L)

ROLAMENTO AGULHA

**VTONB102** F-45713 / 7332316



• ALTERNADOR WAPSA / ARNO / CHEVETTE / OPALA / C-10 / FIAT 147 / GSGI / FIORINO

MEDIDAS EM mm.: 11,11(AB) x 17,4(ABx) x 12,7(L)

ROLAMENTO AGULHA

**VTONB103** F006.919.232



• PARTIDA BOSCH L. MOTRIZ / FIAT 147 / ELBA / PANORAMA / PREMIO / UNO / HONDA CITY / JE

MEDIDAS EM mm.: 15,8(AB) x 20,6(ABx) x 19(L)

ROLAMENTO AGULHA

**VTONB104** 2.000.910.012



• PARTIDA BOSCH INTERMEDIÁRIO / FERRAMENTAS ELÉTRICAS / JE

MEDIDAS EM mm.: 22(AB) x 28(ABx) x 16(L)

ROLAMENTO AGULHA

**VTONB105** 2.000.910.005



• EIXO INDUZIDO PARTIDA BOSCH / KB PEQUENO

MEDIDAS EM mm.: 18(AB) x 24(ABx) x 16(L)

ROLAMENTO AGULHA

**VTONB106** 2.000.910.002

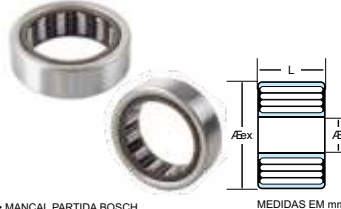

• MANCAL PARTIDA BOSCH / KB BRANCO

MEDIDAS EM mm.: 48(AB) x 33(ABx) x 15(L)

ROLAMENTO AGULHA

**VTONB107** 1.900.910.024



• ALTERNADOR WAPSA / BOSCH 75 A 100A / FERRAMENTAS ELÉTRICAS

MEDIDAS EM mm.: 15(AB) x 35(ABx) x 11(L)

ROLAMENTO AGULHA

**VTONB108** 9.121.456.113



• ALTERNADOR BOSCH 75A / FERRAMENTAS ELÉTRICAS

MEDIDAS EM mm.: 17(AB) x 25(ABx) x 16(L)

ROLAMENTO AGULHA

**VTONB109** 9437171



• ALTERNADOR DELCO 55A

MEDIDAS EM mm.: 17(AB) x 23(ABx) x 23,8(L)

ROLAMENTO AGULHA

**VTONB110** 2.000.910.013



• PARTIDA BOSCH L. MOTRIZ / FERRAMENTAS ELÉTRICAS

MEDIDAS EM mm.: 15(AB) x 23,9(ABx) x 19(L)

ROLAMENTO AGULHA